

F

E

D

C

B

A

1

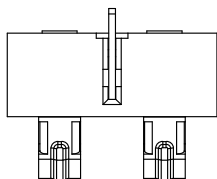
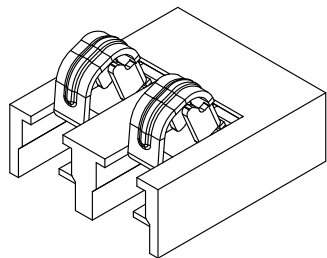

1

性能:

额定电流: 3.0A

额定电压: 24V

耐电压: 500V

接触电阻: 30mΩ MAX

绝缘电阻: 500MΩ

工作温度: -40℃~+85℃

塑件(材质): LCP, 耐高温260℃

接触点(材质): 铜合金, 触点镀金3U

2

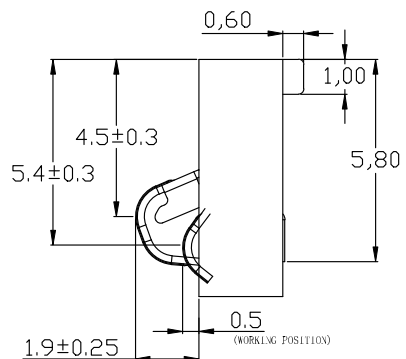
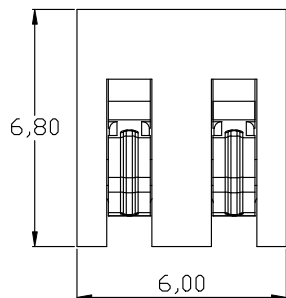

2

3

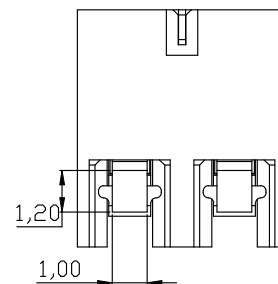
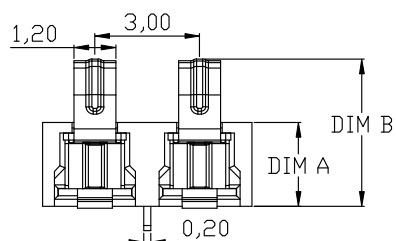

3

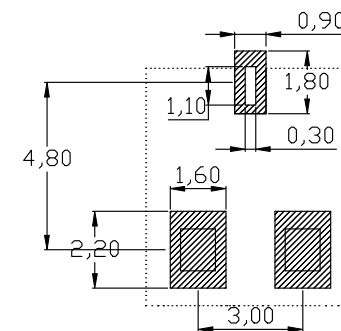

RECOMMENDED PCB LAYOUT
TOP VIEW (.XX±0.05)

4

PART NO.	DIM A	DIM B	2	HOUSING	LCP	1	BLACK
BC-1-216-C01	2.4	4.30±0.25	1	CONTACT TERMINAL	PHOSPHOR BRONZE	3	Au PLATED
BC-1-216A-C01	3.5	5.40±0.25	NO.	PARTS	MATERIAL	QTY.	FINISHING

4

DISONG ELECTRONIC CO., LTD.

COPYRIGHT RESERVED, PLEASE DO NOT COPY.

PART NAME		CONNECTOR		DRAWING	G.B.Wu	DWG.No.	DS-BC-111
PART NO.		BC-1-216/216A-C01		CHECK	Q.L.Dai	REV.	A0
UNIT : mm	TOLERANCE OTHERWISE	UP TO 5	±0.2	APPROVAL	SCALE	DATE	06-09-2017
		ABOVE 5 30 ~	±0.3			PAGE	1 OF 1
		ABOVE 30	±0.5		2:1		
		ANGLE	±3°				

F

E

D

C

B

A